

## A. Edit Spline.

Select Delete Original spline. Follow the prompts.

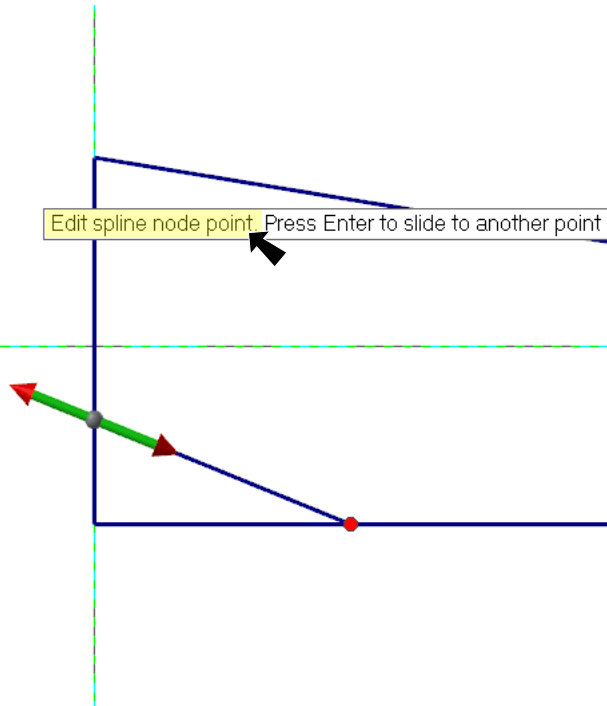

1

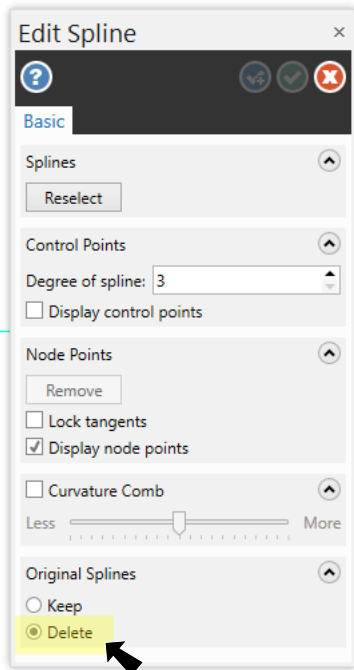
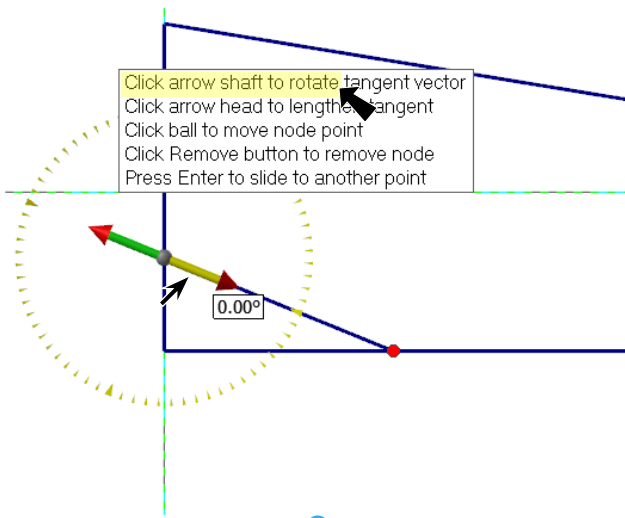

2

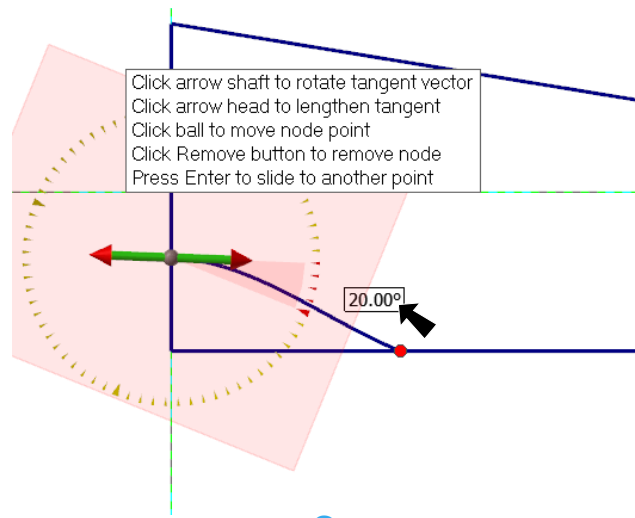

3

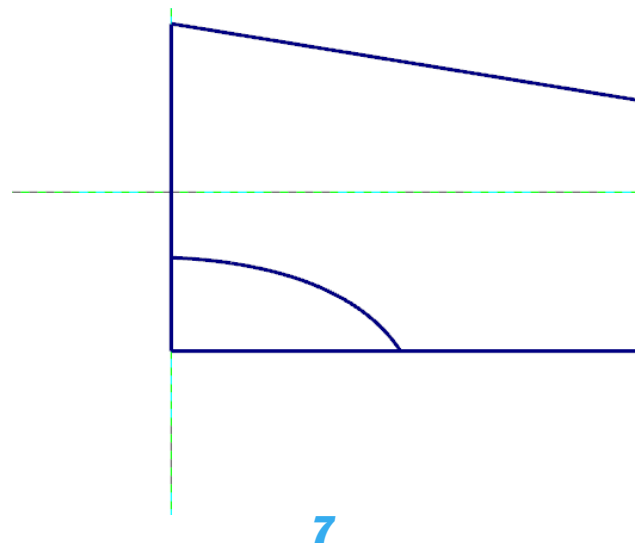
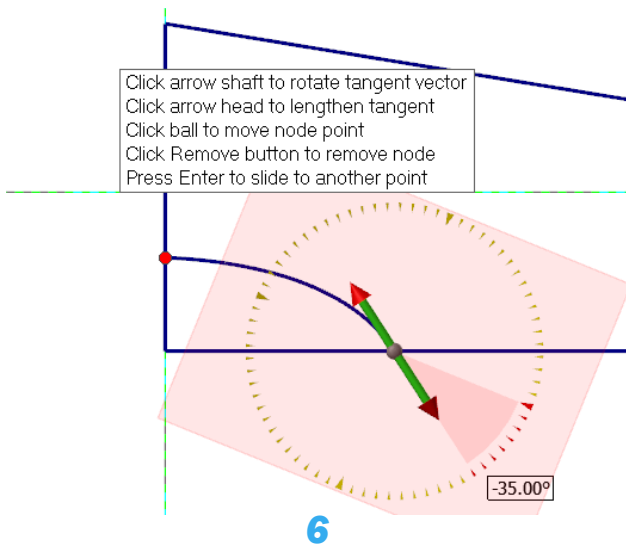
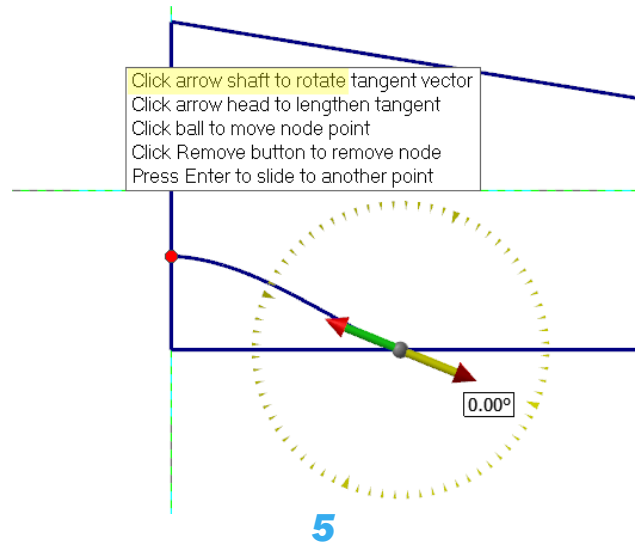
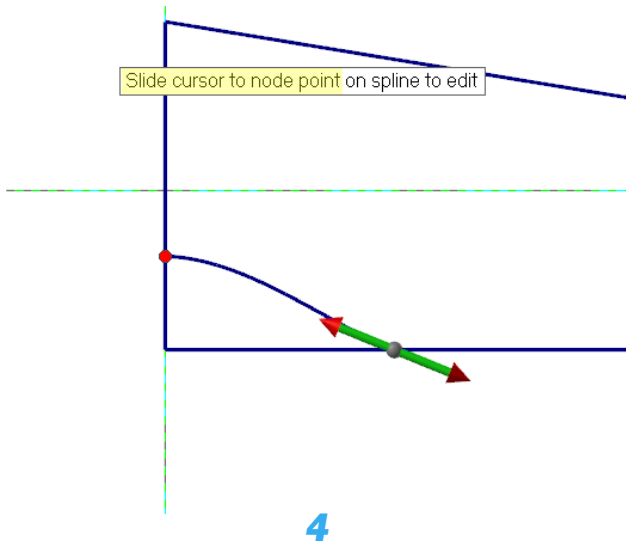

## B. Edit Spline Lengthen Tangent.

Select Delete Original spline. Follow the prompts...Click arrow head.

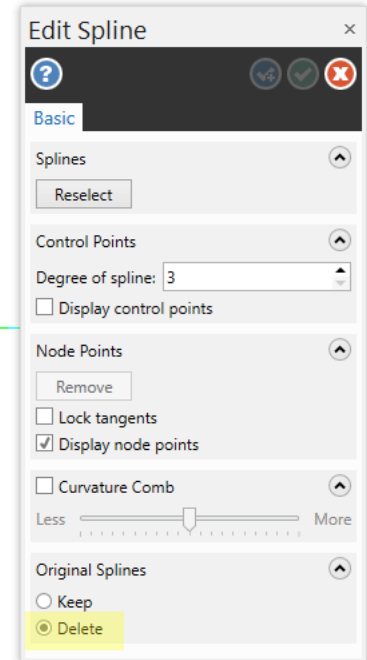
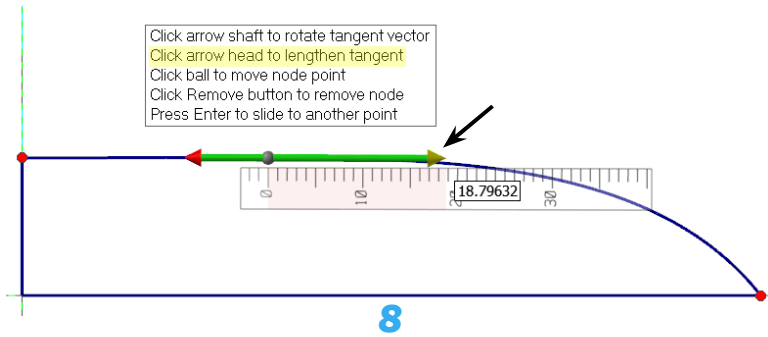

Wanted to move tangent length 8 so I let Mastercam do the math.

