

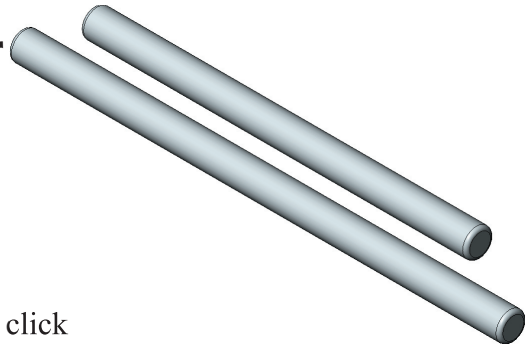



CO2 Rail Car Axles



A. Axle.

Step 1. Click File Menu > New, click **Part Metric** and OK.

Step 2. Click **Right**  (plane) in the Feature Manager and click **Sketch**  from the Content toolbar, **Fig. 1**.

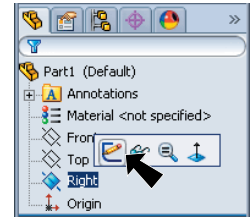

Fig. 1

Step 3. Click **Circle**  (S) on the Sketch toolbar.

Step 4. Draw a circle starting at the Origin , **Fig. 2**.

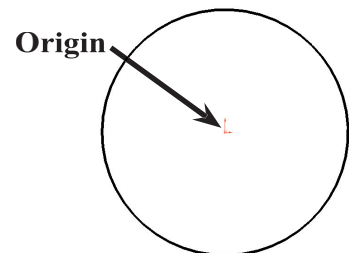

Fig. 2

Step 5. Click **Smart Dimension**  (S) on the Sketch toolbar.

Step 6. Dimension circle **diameter 3.18**, **Fig. 3**.

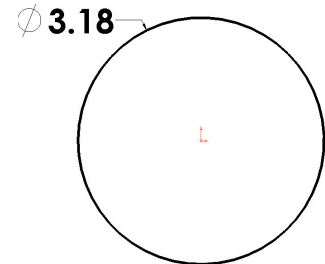
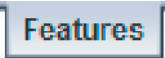
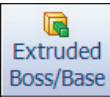

Fig. 3

Step 7. Click **Features**  on the Command Manager toolbar.

Step 8. Click **Extruded Boss/Base**  on the Features toolbar.

Step 9. In the Property Manager, under **Direction 1** set:

End Condition to **Mid Plane**

Depth  D1 to **56**

click **OK** , **Fig. 4**
and **Fig. 5**.

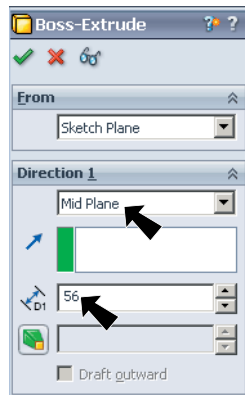



Fig. 4

Step 10. Click **Zoom to Fit**  (F) on the View toolbar.

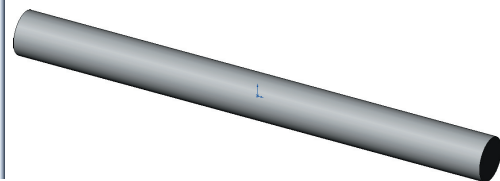



Fig. 5

B. Save as "FRONT AXLE".

Step 1. Click File Menu > Save As.

Step 2. Key-in **FRONT AXLE** for the filename and press ENTER.

C. Fillet Edges.

Step 1. Click **Fillet**  on the Features toolbar.

Step 2. In the Fillet Property Manager:

set **Radius**  to .4

select **Full preview**

click **cylindrical axle face**, **Fig. 7**

click **OK** , **Fig. 8.**

Step 3. Save. Use **Ctrl-S**.

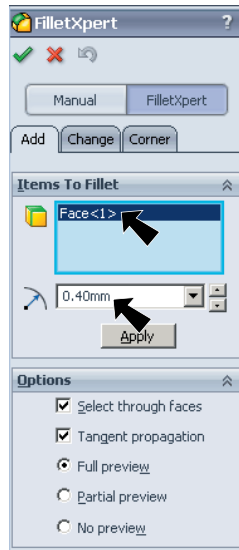

Fig. 6

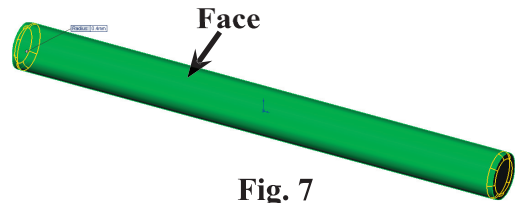

Fig. 7

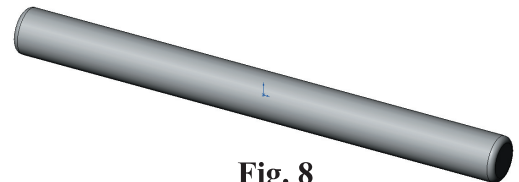



Fig. 8

D. Mate References.

Step 1. Click **Right**  (plane) in the Feature Manager to select Plane, **Fig. 9.**

Step 2. Click **Reference Geometry**  on the Features toolbar and **Mate Reference** from the menu.

Step 3. In the Mate Reference Manager:
under **Primary Reference Entity**, **Fig. 10**

set **Mate Reference Type**  to **Coincident**

under **Secondary Reference Entity**

click in Entity box 

and click **cylindrical face of axle**, **Fig. 11**

click **OK** .

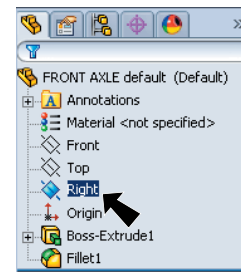

Fig. 9

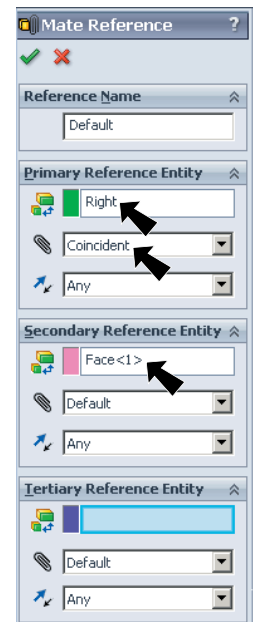

Fig. 10

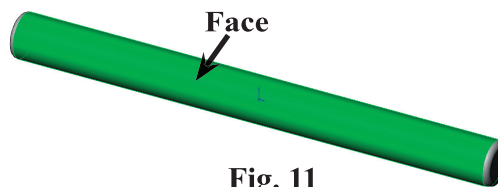



Fig. 11

E. Material Aluminum.

Step 1. Right click Material  in the Feature Manager and click Edit Material, Fig. 12.

Step 2. Expand Aluminum Alloys in the material tree and select 1060 Alloy, Fig. 13. Click Apply and Close.

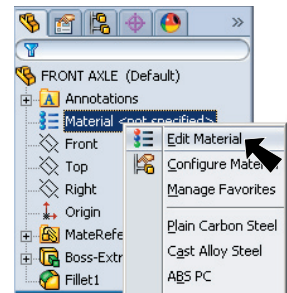

Fig. 12

F. Save as "REAR AXLE".

Step 1. Save.
Use **Ctrl-S** to save FRONT AXLE.

Step 2. Click File Menu > Save As.

Step 3. Key-in **REAR AXLE** for the filename.
You now have two axle files, FRONT and REAR. Next, we change length of REAR axle.

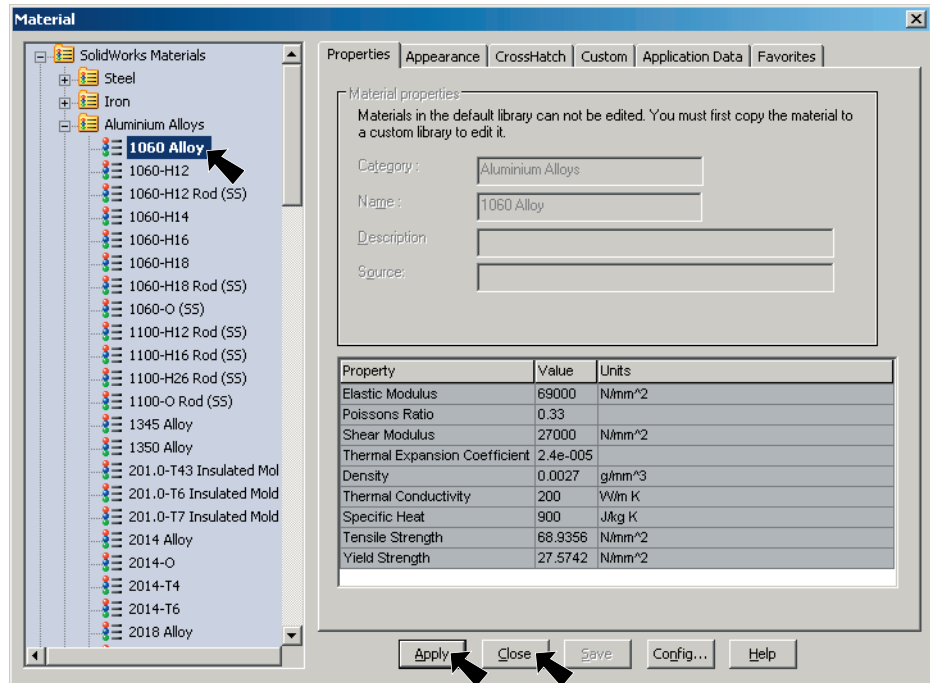



Fig. 13

G. Change Extrude Depth.

Step 1. Click **Boss-Extrude1** in the Feature Manager and click Edit Feature  in the menu, Fig. 14.

Step 2. Change **Depth**  to 44
click OK , Fig. 15.

Step 3. Save. Use **Ctrl-S**.

You should have 2 axles:
FRONT 56
REAR 44

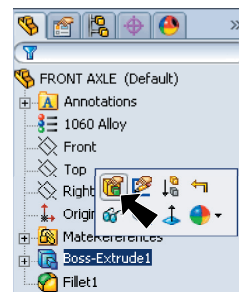

Fig. 14

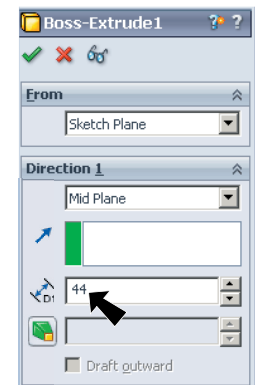

Fig. 15

