



A. Wheel.

Step 1. Click File Menu > New, click **Part** and OK.

Step 2. Click **Right Plane**  in the Feature Manager and click **Sketch**  from the Content toolbar, **Fig. 1**.

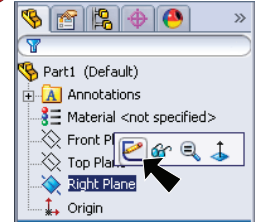

Fig. 1

Step 3. Click **Circle**  (S) on the Sketch toolbar.

Step 4. Draw **two circles** starting at the Origin , **Fig. 2**.

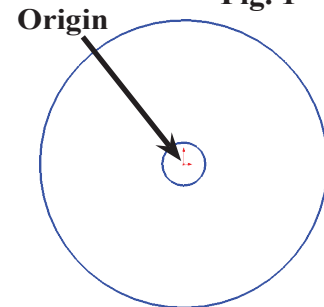

Fig. 2

Step 5. Click **Smart Dimension**  (S) on the Sketch toolbar.

Step 6. Dimension the circles as shown in **Fig. 3**.

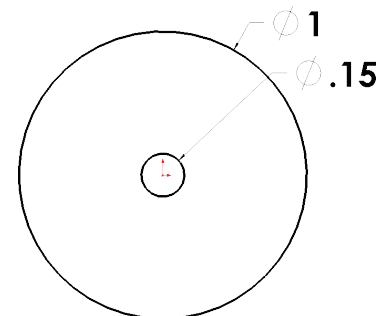
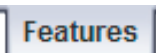

Fig. 3

Step 7. Click **Features**  on the Command Manager toolbar.

Step 8. Click **Extruded Boss/Base**  on the Features toolbar.

Step 9. In the Property Manager set:

Depth  D1 to **.5**

click OK , **Fig. 4** and **Fig. 5**.

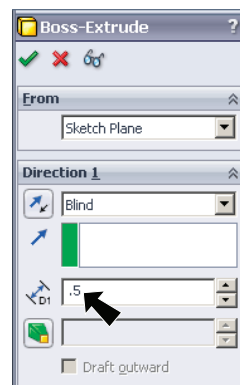

Fig. 4

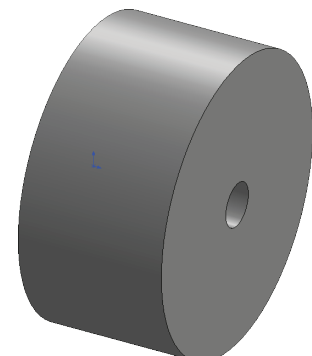

Fig. 5

Step 10. Click Zoom to Fit  (F) on the View toolbar.

B. Save as "WHEEL".

Step 1. Click File Menu > Save As.

Step 2. Key-in **WHEEL** for the filename and press ENTER.

C. Spoke Sketch.

Step 1. Click the **side face** and click **Sketch**  on the Content menu, **Fig. 6**.

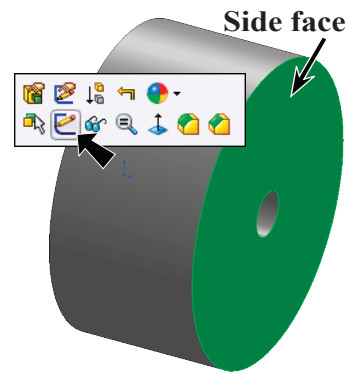



Fig. 6

Step 2. Click **Normal To**  on the Standard Views toolbar. (**Ctrl-8**)

Step 3. Click **Circle**  (S) on the Sketch toolbar.

Step 4. Draw **two circles** starting at the Origin , **Fig. 7**.

Step 5. Click **Smart Dimension**  (S) on the Sketch toolbar.

Step 6. Dimension the circles as shown in **Fig. 7**.

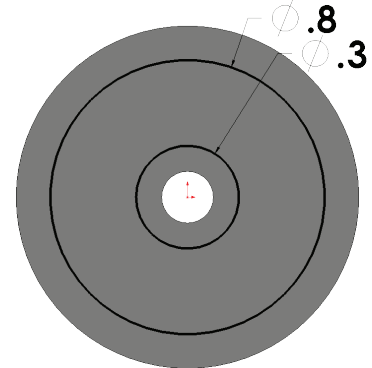





Fig. 7

Step 7. Click **Centerline**  (S) in the **Line flyout**  on the Sketch toolbar.

Step 8. Draw a centerline from the Origin  **up to edge of Wheel**, **Fig. 8**. Keep centerline vertical.

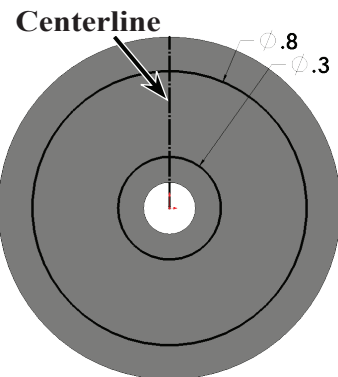

Fig. 8

Step 9. Click **Offset Entities**  on the Sketch toolbar.

Step 10. In the Offset Entities Property Manager set:

Distance  **D1 to .06** **Fig. 9**

check Bi-directional

click the centerline, **Fig. 10**

The yellow offset should be on both side of centerline, **Fig. 10**.

Click OK  when done.

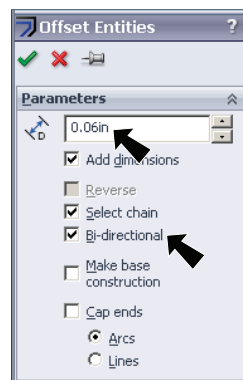

Fig. 9

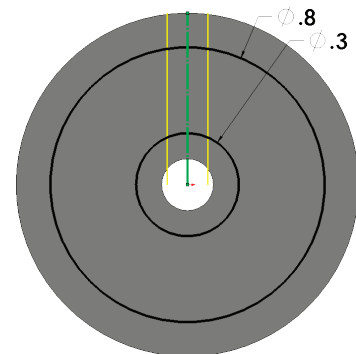



Fig. 10

D. Trim.

Step 1. Click **Trim Entities**  (S) on the Sketch toolbar.

Step 2. In the Property Manger select **Trim to closest** , Fig. 11.

Step 3. Trim away lines outside big circle and inside small circle, Fig. 12. Click line you want to trim away. Results shown in Fig. 13. Click OK  when done.

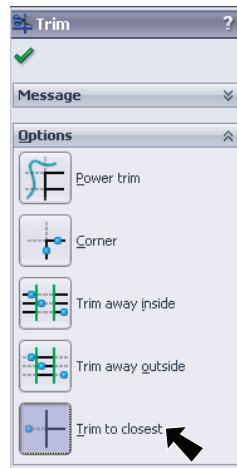

Fig. 11

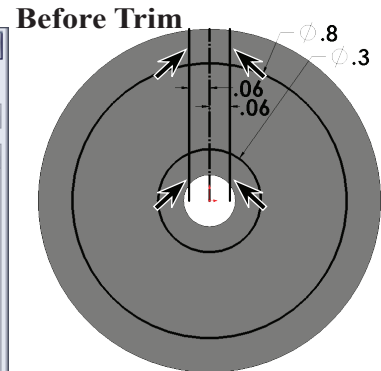

Fig. 12

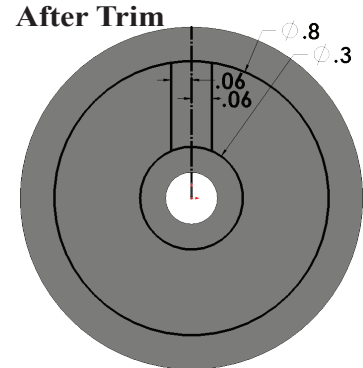



Fig. 13

E. Circular Sketch Pattern.

Step 1. Click **Circular Sketch Pattern**  in the **Linear Sketch Pattern** flyout on the Sketch toolbar.

Step 2. In the Circular Sketch Pattern Property Manager set:

under Parameters,
check **Equal spacing**, Fig. 14

Number of Instances  to 6

under Entities to Pattern
click **both offset lines** in sketch,
Fig. 15

Pattern Axis 
the sketch **Origin (Point 1)** should be selected as
default, Fig. 14

click OK , Fig. 16.

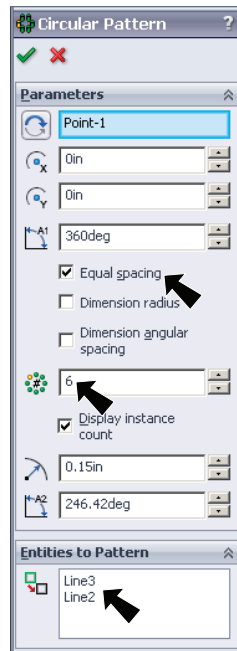

Fig. 14

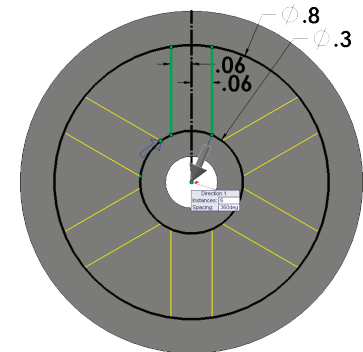

Fig. 15

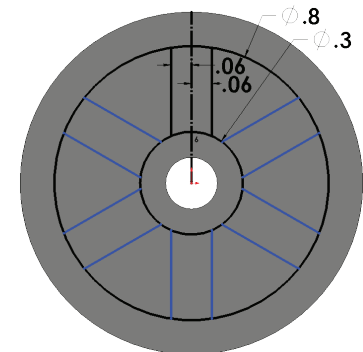
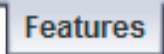
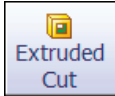

Fig. 16

F. Extruded Cut Spokes.

Step 1. Click **Features**  on the Command Manager toolbar.

Step 2. Click **Extruded Cut**  on the Features toolbar.

Step 3. In the Cut-Extrude Property Manager set:
under Direction1, **Fig. 17**
End Condition to Through All

under Selected Contours
click each wedge shaped contour
between spokes, Fig. 18

and click OK .

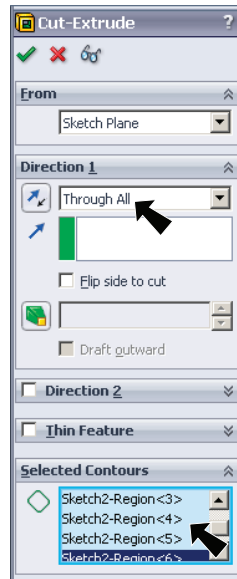

Fig. 17

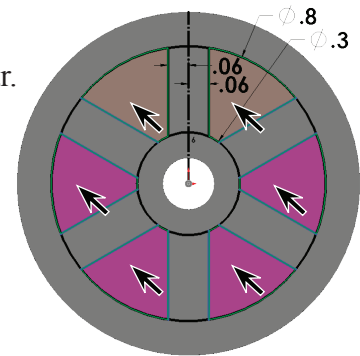

Fig. 18

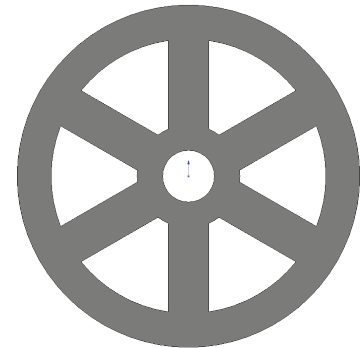
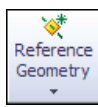

Fig. 19

G. Mate Reference.

Step 1. Click **Trimetric**  on the Standard Views toolbar.

Step 2. Click the **inside cylindrical face of axle hole** to select it, Fig. 20.

Step 3. Click **Reference Geometry**  on the Features toolbar and **Mate Reference** from the menu.

Step 4. In the Mate Reference Property Manager click OK , Fig. 21.

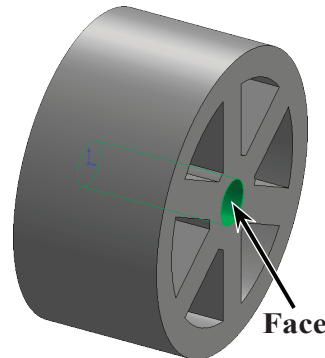

Fig. 20

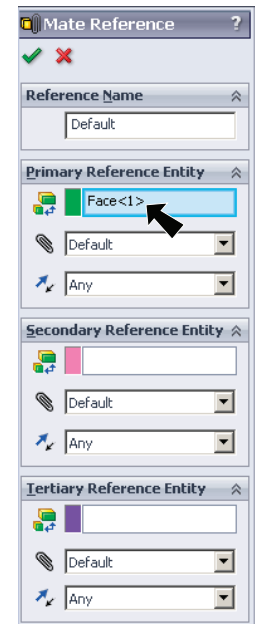

Fig. 21

H. Material POM Acetal Copolymer.

Step 1. **Right click Material**  in the Feature Manager and click **Edit Material**, Fig. 22.

Step 2. **Expand Plastics** in the material tree and select **POM Acetal Copolymer**. Click **Apply** and **Close**.

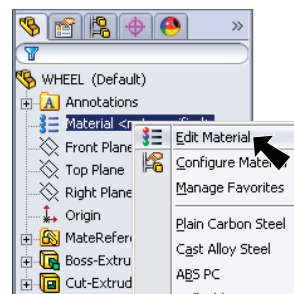

Fig. 22

I. Appearance.

Step 1. Click the part to select the part, click **Appearance Callout**



on the Content menu and click **WHEEL** , Fig. 23.

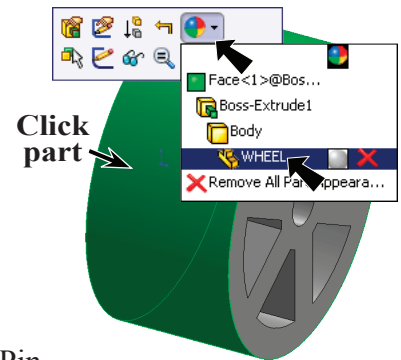

Fig. 23

Step 2. In the Appearances Property Manager, Fig. 24

under Color
click the **red swatch**

click **Keep Visible**  and OK , Fig. 24. The Push Pin  on allows selection of another appearance.

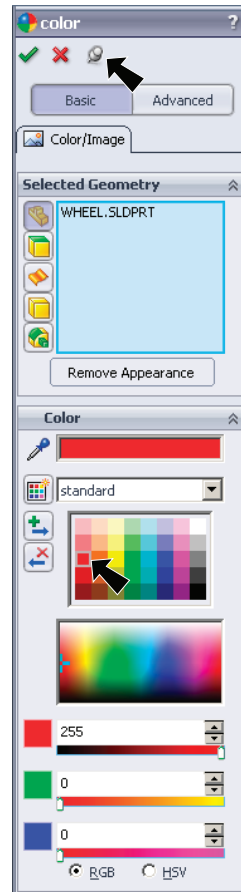

Fig. 24

Step 3. In the Appearances Property Manager,

under Selected Geometry
click **Select Features** , Fig. 26

click **one Extruded cut between spokes**,
Fig. 27

under Color:
click the **white swatch**, Fig. 26.

click OK  and
click Cancel .

Step 4. Save. Use **Ctrl-S**.

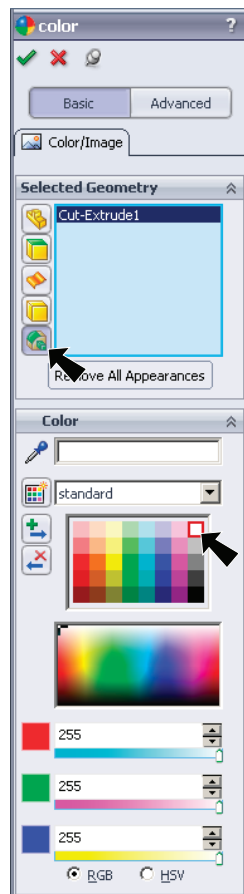

Fig. 26

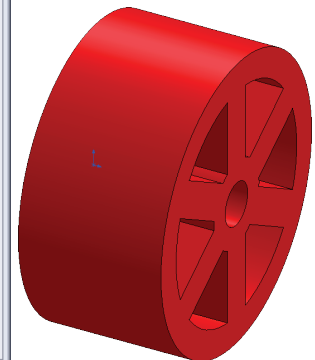

Fig. 25

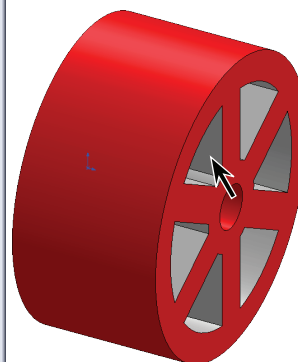

Fig. 27