

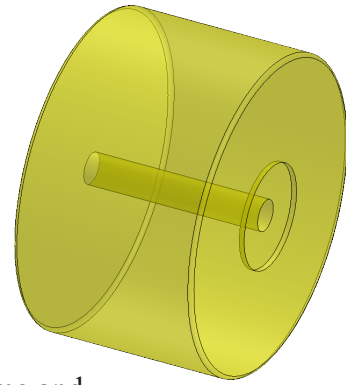

CO2 Rail Car E Rear Wheel



A. Save As.

- Step 1. Open your **FRONT WHEEL** file.
- Step 2. Click File Menu > Save As.
- Step 3. In the Save As dialog box, key-in **REAR WHEEL** for filename and click Save.

B. Edit Revolve Sketch.

- Step 1. Click **Revolve1** in the Feature Manager and **Edit Sketch**  on the context toolbar, **Fig. 1**.
- Step 2. Click **Normal To**  on the Standard Views toolbar. (**Ctrl-8**)
- Step 3. **Delete two angled lines and 5 dimension, Fig. 2 and Fig. 3.** To delete, Ctrl click the two lines and dimension and press Delete key.

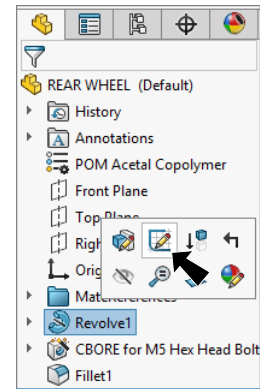

Fig. 1

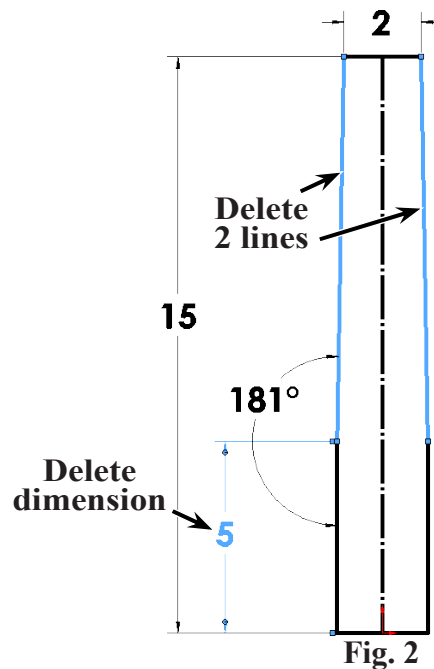

Fig. 2

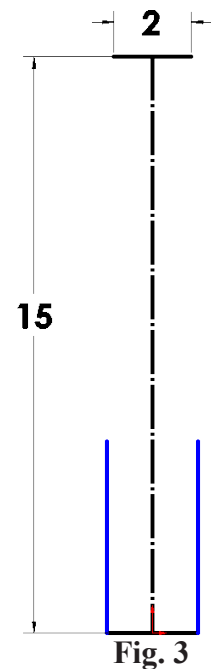



Fig. 3

Step 4. Click **Trim Entities**  (S) on the Sketch toolbar.

Step 5. In the Trim Property Manger select:

Corner , Fig. 4.

Click vertical line and horizontal line at top to trim/extend to corner, Fig. 5.

Results shown in Fig. 6.

Repeat on other side, click other vertical line and horizontal line at top to trim to corner, Fig. 7.

Results shown in Fig. 8.

Click OK .

Step 6. Click **Smart Dimension**

 (S) on the Sketch toolbar.

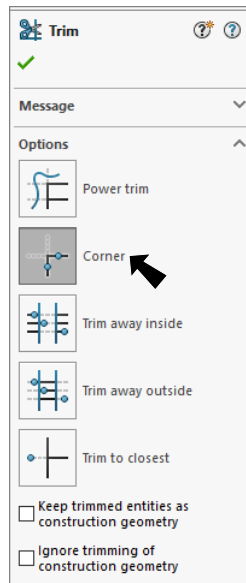
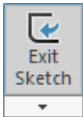

Fig. 4

Step 7. Dimension top line 18, Fig. 9.

Step 8. Click **Exit Sketch**  on the Sketch toolbar.

Step 9. Click **Trimetric**  on the Standard Views toolbar.

Step 10. Save. Use **Ctrl-S**.

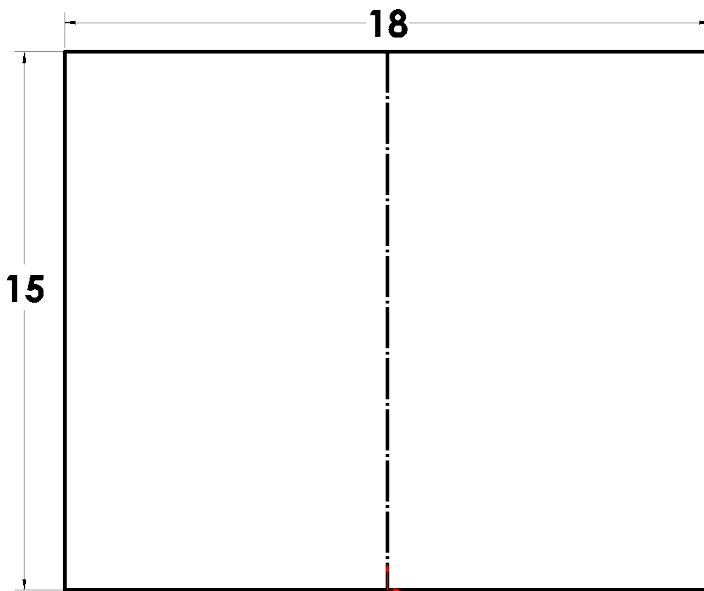

Fig. 9

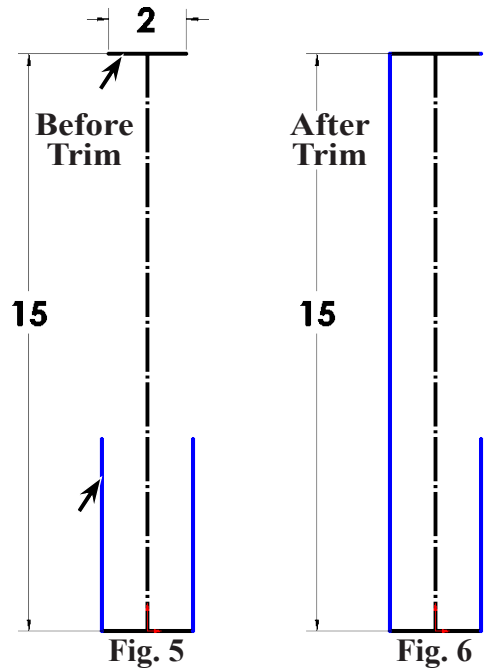

Fig. 5

Fig. 6

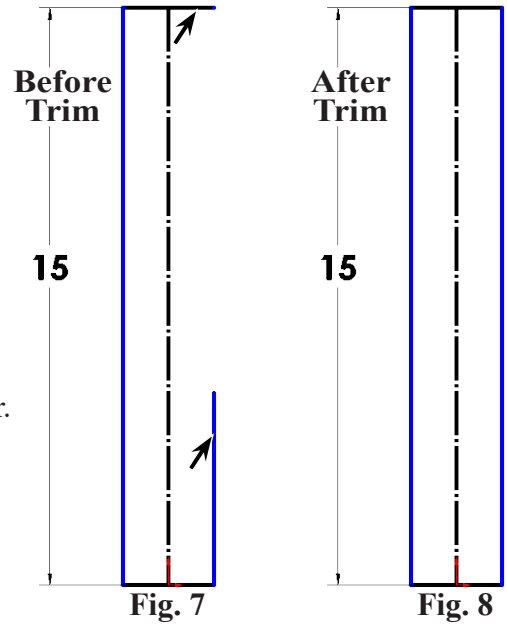

Fig. 7

Fig. 8

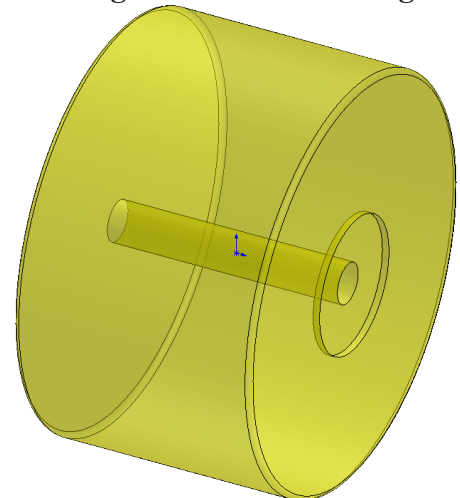

Fig. 10